



Operating Instructions

Blu-ray Disc™ / DVD Player

BDP-S185/BX18

WARNING

To reduce the risk of fire or electric shock, do not expose this apparatus to rain or moisture.

To avoid electrical shock, do not open the cabinet. Refer servicing to qualified personnel only.

The AC power cord must be changed only at a qualified service shop.

Batteries or batteries installed apparatus shall not be exposed to excessive heat such as sunshine, fire or the like.

CAUTION

The use of optical instruments with this product will increase eye hazard. As the laser beam used in this Blu-ray Disc/DVD player is harmful to eyes, do not attempt to disassemble the cabinet.

Refer servicing to qualified personnel only.

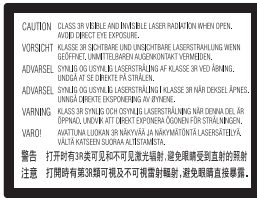

This label is located on the laser protective housing inside the enclosure.

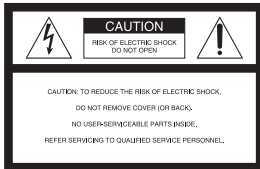

This symbol is intended to alert the user to the presence of uninsulated “dangerous voltage” within the product’s enclosure that may be of sufficient magnitude to constitute a risk of electric shock to persons.



This symbol is intended to alert the user to the presence of important operating and maintenance (servicing) instructions in the literature accompanying the appliance.

Precautions

- To prevent fire or shock hazard, do not place objects filled with liquids, such as vases, on the apparatus.
- Install this unit so that the AC power cord can be unplugged from the wall socket immediately in the event of trouble.

FCC WARNING

You are cautioned that any changes or modifications not expressly approved in this manual could void your authority to operate this equipment.

The shielded Interface cable (LAN cable) must be used with the equipment in order to comply with the limits for a digital device pursuant to Subpart B of Part 15 of FCC Rules.



This equipment has been tested and found to comply with the limits for a Class B digital device, pursuant to Part 15 of the FCC Rules. These limits are designed to provide reasonable protection against harmful interference in a residential installation. This equipment generates, uses, and can radiate radio frequency energy and, if not installed and used in accordance with the instructions, may cause harmful interference to radio communications. However, there is no guarantee that interference will not occur in a particular installation. If this equipment does cause harmful interference to radio or television reception, which can be determined by turning the equipment off and on, the user is encouraged to try to correct the interference by one or more of the following measures:

- Reorient or relocate the receiving antenna.
- Increase the separation between the equipment and receiver.
- Connect the equipment into an outlet on a circuit different from that to which the receiver is connected.
- Consult the dealer or an experienced radio/TV technician for help.

Important Safety Instructions

- 1) Read these instructions.
- 2) Keep these instructions.
- 3) Heed all warnings.
- 4) Follow all instructions.
- 5) Do not use this apparatus near water.
- 6) Clean only with dry cloth.
- 7) Do not block any ventilation openings. Install in accordance with the manufacturer’s instructions.
- 8) Do not install near any heat sources such as radiators, heat registers, stoves, or other apparatus (including amplifiers) that produce heat.
- 9) Do not defeat the safety purpose of the polarized or grounding-type plug. A polarized plug has two blades with one wider than the other. A grounding type plug has two blades and a third grounding prong. The wide blade or the third prong are provided for your safety. If the provided plug does not fit into your outlet, consult an electrician for replacement of the obsolete outlet.
- 10) Protect the power cord from being walked on or pinched particularly at plugs, convenience receptacles, and the point where they exit from the apparatus.

- 1) Only use attachments/accessories specified by the manufacturer.
- 2) Use only with the cart, stand, tripod, bracket, or table specified by the manufacturer, or sold with the apparatus. When a cart is used, use caution when moving the cart/apparatus combination to avoid injury from tip-over.



- 13) Unplug this apparatus during lightning storms or when unused for long periods of time.
- 14) Refer all servicing to qualified service personnel. Servicing is required when the apparatus has been damaged in any way, such as power-supply cord or plug is damaged, liquid has been spilled or objects have fallen into the apparatus, the apparatus has been exposed to rain or moisture, does not operate normally, or has been dropped.

Owner's Record

The model and serial numbers are located at the rear of the unit. Record the serial number in the space provided below. Refer to them whenever you call upon your Sony dealer regarding this product.

Model No. _____

Serial No. _____

For customers in the USA

If this product is not working properly, please call 1-866-909-7669.

For Customers in Canada

If this product is not working properly, please contact our **Customer Information Service Center** at 1-877-899-7669 or write to us at: Customer Information Service 115 Gordon Baker Road, Toronto, Ontario, M2H 3R6

Precautions

This equipment has been tested and found to comply with the limits set out in the EMC Directive using a connection cable shorter than 3 metres.

On placement

- Place the player in a location with adequate ventilation to prevent heat build-up in the player.
- Do not place the player on a soft surface such as a rug that might block the ventilation holes.
- Do not install this player in a confined space, such as a bookshelf or similar unit.
- Do not place the player in a location near heat sources, or in a place subject to direct sunlight, excessive dust, or mechanical shock.
- Do not place the player outdoors, in vehicles, on ships, or on other vessels.

- If the player is brought directly from a cold to a warm location, or is placed in a very damp room, moisture may condense on the lenses inside the player. Should this occur, the player may not operate properly. In this case, remove the disc and leave the player turned on for about half an hour until the moisture evaporates.
- Do not install the player in an inclined position. It is designed to be operated in a horizontal position only.
- Do not place heavy or unstable objects on the player.
- Do not place any objects other than discs on the disc tray. Doing so may cause damage to the player or the object.
- Take out any discs when you move the player. If you don't, the disc may be damaged.
- Disconnect the AC power cord and all other cables from the player when you move the player.

On power sources

- The player is not disconnected from the AC power source as long as it is connected to the wall outlet, even if the player itself has been turned off.
- Disconnect the player from the wall outlet if you are not going to use the player for a long time. To disconnect the AC power cord, grasp the plug itself; never pull the cord.
- Observe following points to prevent the AC power cord being damaged. Do not use the AC power cord if it is damaged, as doing so may result in an electric shock or fire.
 - Do not pinch the AC power cord between the player and wall, shelf, etc.
 - Do not put anything heavy on the AC power cord or pull on the AC power cord itself.

On adjusting volume

Do not turn up the volume while listening to a section with very low level inputs or no audio signals. Your ears and the speakers may be damaged when the sound level reaches the peak.

On cleaning

Clean the cabinet, panel, and controls with a soft cloth. Do not use any type of abrasive pad, scouring powder or solvent such as alcohol or benzene.

On cleaning discs, disc/lens cleaners

Do not use cleaning discs or disc/lens cleaners (including wet or spray types). These may cause the apparatus to malfunction.

On replacement of parts

In the events that this player is repaired, repaired parts may be collected for reuse or recycling purposes.

On connecting to the HDMI OUT jack

Observe the following as improper handling may damage the HDMI OUT jack and the connector.

- Carefully align the HDMI OUT jack on the rear of the player and the HDMI connector by checking their shapes. Make sure the connector is not upside down or tilted.

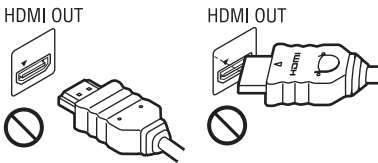

- Be sure to disconnect the HDMI cable when moving the player.



- Hold the HDMI connector straight when connecting or disconnecting the HDMI cable. Do not twist or force the HDMI connector into the HDMI OUT jack.

IMPORTANT NOTICE

Caution: This player is capable of holding a still video image or on-screen display image on your television screen indefinitely. If you leave the still video image or on-screen display image displayed on your TV for an extended period of time you risk permanent damage to your television screen. Plasma display panel televisions and projection televisions are susceptible to this.

If you have any questions or problems concerning your player, please consult your nearest Sony dealer.

Copy Protection

Please be advised of the advanced content protection systems used in both Blu-ray Disc™ and DVD media. These systems, called AAC (Advanced Access Content System) and CSS (Content Scramble System), may contain some restrictions on playback, analog output, and other similar features. The operation of this product and the restrictions placed may vary depending on the date of purchase, as the governing board of the AAC may adopt or change its restriction rules after the time of purchase.

Copyrights and Trademarks

- “AVCHD” and the “AVCHD” logo are trademarks of Panasonic Corporation and Sony Corporation.

- Java is a trademark of Oracle and/or its affiliates.
- “XMB,” and “cross media bar” are trademarks of Sony Corporation and Sony Computer Entertainment Inc.
- This product incorporates High-Definition Multimedia Interface (HDMI™) technology. HDMI, the HDMI logo and High-Definition Multimedia Interface are trademarks or registered trademarks of HDMI Licensing LLC in the United States and other countries.
- “Blu-ray Disc” is a trademark.
- “Blu-ray Disc,” “DVD+RW,” “DVD-RW,” “DVD+R,” “DVD-R,” “DVD VIDEO,” and “CD” logos are trademarks.
- “BD-LIVE,” “BD-LIVE” logo, and “BONUSVIEW” are trademarks of Blu-ray Disc Association.
- “x.v.Color” and “x.v.Color” logo are trademarks of Sony Corporation.
- “BRAVIA” is a trademark of Sony Corporation.
- “PhotoTV HD” and the “PhotoTV HD” logo are trademarks of Sony Corporation.
- MPEG Layer-3 audio coding technology and patents licensed from Fraunhofer IIS and Thomson.
- Windows Media is either a registered trademark or trademark of Microsoft Corporation in the United States and/or other countries. This product contains technology subject to certain intellectual property rights of Microsoft. Use or distribution of this technology outside of this product is prohibited without the appropriate license(s) from Microsoft. Content owners use Microsoft PlayReady™ content access technology to protect their intellectual property, including copyrighted content. This device uses PlayReady technology to access PlayReady-protected content and/or WMDRM-protected content. If the device fails to properly enforce restrictions on content usage, content owners may require Microsoft to revoke the device’s ability to consume PlayReady-protected content. Revocation should not affect unprotected content or content protected by other content access technologies. Content owners may require you to upgrade PlayReady to access their content. If you decline an upgrade, you will not be able to access content that requires the upgrade.
- This product meets ENERGY STAR® guidelines for energy efficiency. ENERGY STAR and the ENERGY STAR mark are registered U.S. marks. ENERGY STAR is a registered mark owned by the U.S. government.
- All other trademarks are trademarks of their respective owners.
- Other system and product names are generally trademarks or registered trademarks of the manufacturers. ™ and ® marks are not indicated in this document.

Table of Contents

WARNING	2
Precautions	3
Guide to Parts and Controls	6

Hookups and Settings

Step 1: Connecting the Player	9
Step 2: Easy Setup	11
Connecting to the Network	11

Playback

Playing a Disc	12
Playing from a USB Device	13
Playing via a Network	13
Available Options	14

Settings and Adjustments

Using the Settings Displays	15
[Network Update]	15
[Screen Settings]	15
[Audio Settings]	16
[BD/DVD Viewing Settings]	17
[Parental Control Settings]	17
[System Settings]	18
[Network Settings]	18
[Easy Setup]	18
[Resetting]	18

Additional Information

Troubleshooting	19
Specifications	21
Index	25

Guide to Parts and Controls

Front panel

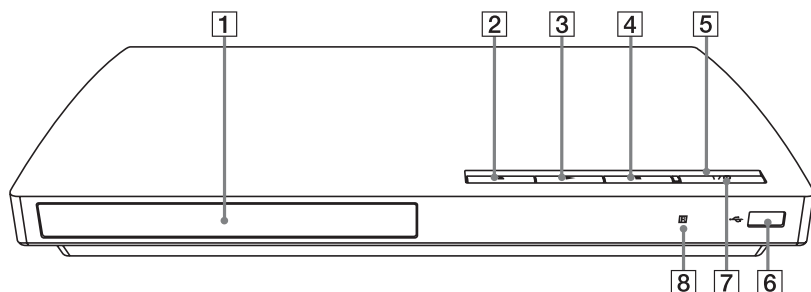

The ► button has a tactile dot. Use the tactile dot as a reference when operating the player.

1 Disc tray

2 ▲ (open/close)

3 ► (play)

4 ■ (stop)

5 Power indicator

Lights up when the player is turned on.

6 USB jack

Connect a USB device to this jack.

7 I/O (on/standby)

Turns on the player, or sets to standby mode.

8 Remote sensor

To lock the disc tray (Child Lock)

You can lock the disc tray to avoid accidental opening of the tray.

While the player is turned on, hold down the ► button on the player for more than 10 seconds to lock or unlock the tray.

Rear panel

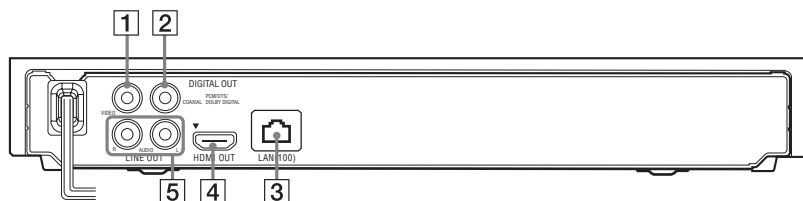

1 LINE OUT (VIDEO) jack

2 DIGITAL OUT (COAXIAL) jack

3 LAN (100) terminal

4 HDMI OUT jack

5 LINE OUT (R-AUDIO-L) jacks

Remote

The available functions of the remote differ depending on the disc or the situation.

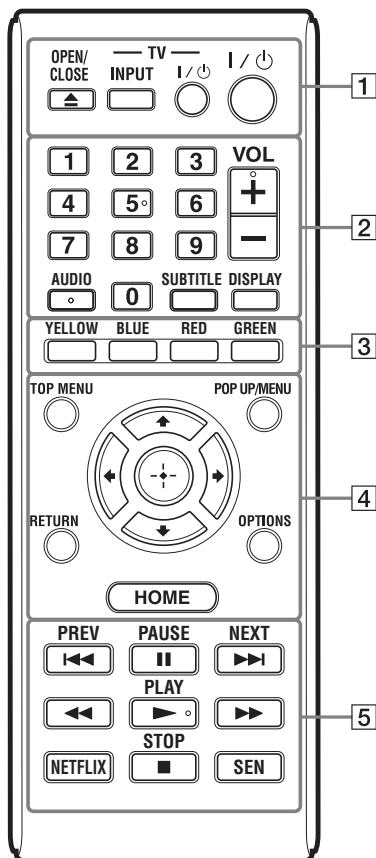

Number 5, AUDIO, VOL +, and ► PLAY buttons have a tactile dot. Use the tactile dot as a reference when operating the player.

The player automatically returns to standby mode

If any button on the player or remote is not pressed for more than 30 minutes, the player automatically returns to standby mode.

1 ▲ OPEN/CLOSE

Opens or closes the disc tray.

-TV- INPUT

Switches between TV and other input sources.

-TV- I/⏻

Turns on the TV, or sets to standby mode.

I/⏻

Turns on the player, or sets to standby mode.

2 Number buttons (0 - 9)

Enters the title/chapter numbers, etc.

VOL +/-

Adjusts the TV volume.

AUDIO (page 17)

Selects the language track when multi-lingual tracks are recorded on BD-ROMs/DVD VIDEOS.

Selects the sound track on CDs.

SUBTITLE (page 17)

Selects the subtitle language when multi-lingual subtitles are recorded on BD-ROMs/DVD VIDEOS.

DISPLAY (page 12)

Displays the playback information on the screen.

3 Color buttons (YELLOW/BLUE/RED/GREEN)

Shortcut keys for interactive functions.

4 TOP MENU

Opens or closes the BD's or DVD's Top Menu.

POP UP/MENU

Opens or closes the BD-ROM's Pop-up Menu, or the DVD's menu.

OPTIONS (page 14)

Displays the available options on the screen.

HOME

Enters the player's home menu.

Displays the wall paper when pressed on the category icon of the home menu.

RETURN

Returns to the previous display.



Moves the highlight to select a displayed item.

Center button (ENTER)

Enters the selected item.

5 ◀◀ PREV/NEXT ▶▶

Skips to the previous/next chapter, track, or file.

⏸ PAUSE

Pauses or re-starts playback.

◀◀/▶▶ (fast reverse/fast forward)

- Fast reverses/fast forwards the disc when pressed during playback. Each time you press the button during playback of videos, the search speed changes.
- Plays in slow motion, when pressed for more than one second in pause mode.
- Plays one frame at a time, when pressed briefly in pause mode.

▶▶ PLAY

Starts or re-starts playback.

NETFLIX (page 13)

Accesses the “NETFLIX” online service.

■ STOP

Stops playback and remembers the stop point (resume point).

The resume point for a title/track is the last point you played or the last photo for a photo folder.

SEN

Accesses the “Sony Entertainment Network™” online service.

Home menu display

The home menu appears when you press HOME. Select a category using ◀/▶. Select an item using ↑/↓, and press ENTER.

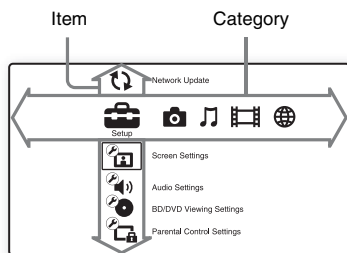

- [Setup]: Adjusts the player settings.
- [Photo]: Displays photos.
- [Music]: Plays music.
- [Video]: Plays videos.
- [Network]: Displays network items.

Step 1: Connecting the Player

Do not connect the AC power cord until you have made all the connections.
For supplied accessories, see page 21.

Connecting to your TV

Select one of the following connection methods according to the input jacks on your TV.
Match the color of the plug to that of the jack when connecting.

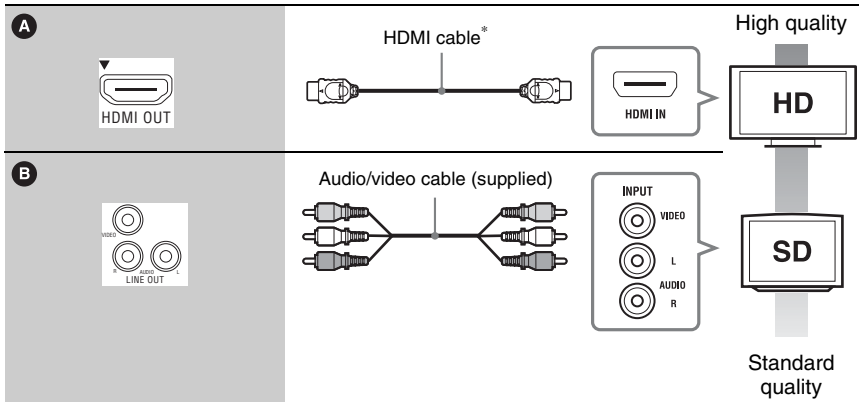
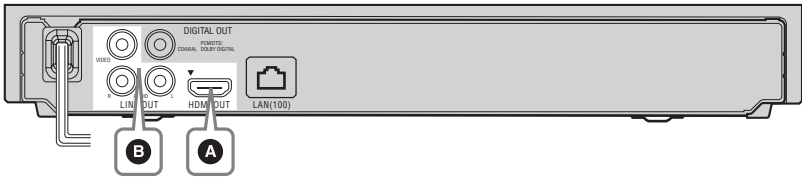

* See "Supplied accessories" (page 21)

 Do not connect the player through a VCR. Video signals fed through VCRs may be affected by copyright protection systems and the picture will be distorted on the television.

Connecting to your AV amplifier (receiver)

Select one of the following connection methods according to the input jacks on your AV amplifier (receiver). When you select **A** or **B**, make the appropriate settings in the [Audio Settings] setup (page 16).

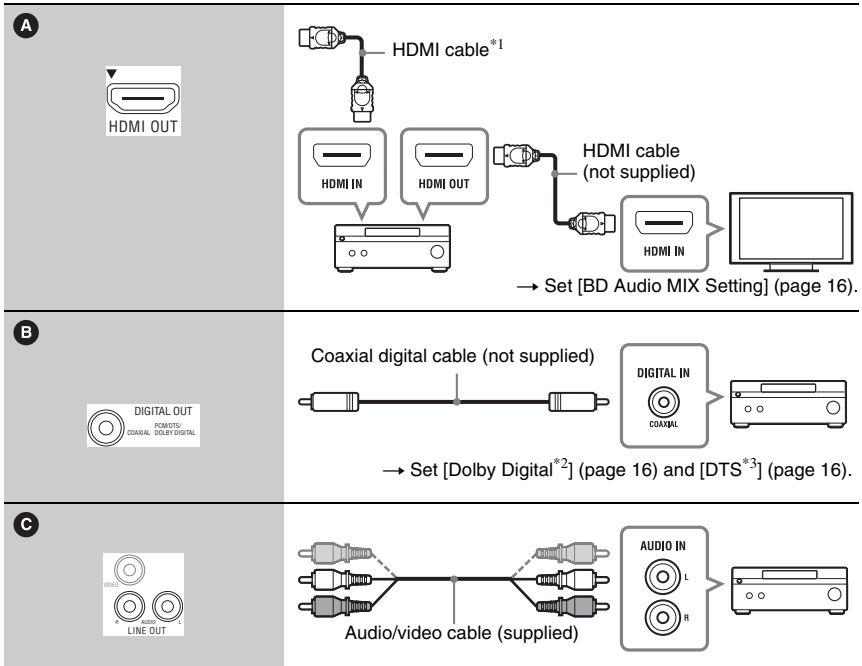
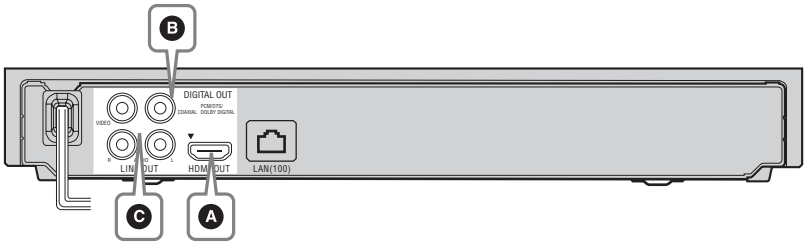

*¹ See “Supplied accessories” (page 21).

*² Manufactured under license from Dolby Laboratories.
Dolby, Pro Logic, and the double-D symbol are trademarks of Dolby Laboratories.

*³ Manufactured under license under U.S. Patent #'s: 5,451,942; 5,956,674; 5,974,380; 5,978,762; 6,226,616; 6,487,535; 7,212,872; 7,333,929; 7,392,195; 7,272,567 & other U.S. and worldwide patents issued & pending. DTS and the Symbol are registered trademarks, & DTS-HD, DTS-HD Master Audio, and the DTS logos are trademarks of DTS, Inc. Product includes software. © DTS, Inc. All Rights Reserved.

Step 2: Easy Setup

When turned on for the first time

Wait for a short while before the player turns on and starts [Easy Setup].

- 1 Insert two Size AA (R6) batteries by matching the ⊕ and ⊖ ends on the batteries to the markings inside the battery compartment.

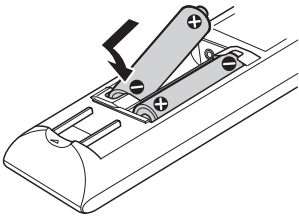

- 2 Plug the player into the AC outlet.

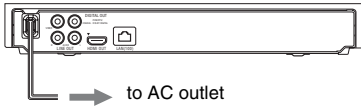

- 3 Press I/⏻ to turn on the player.

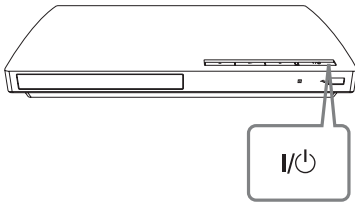

- 4 Turn on the TV, then switch the input selector on your TV so that the signal from the player appears on your TV screen.

- 5 Perform [Easy Setup].

Follow the on-screen instructions to make the basic settings using

←/↑/↓/→ and ENTER on the remote.

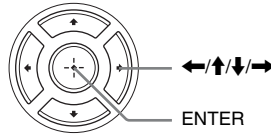

Connecting to the Network

Wired Setup

Use a LAN cable to connect to the LAN (100) terminal on the player.

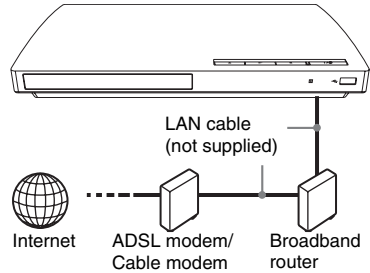

Using a shielded interface cable (LAN cable), straight or crossing, is recommended.

To set the network settings

Select [Network Settings], [Internet Settings], then [Wired Setup] (page 18), and follow the on-screen instructions to complete the setup.

Playing a Disc

For playable discs, see page 22.

- 1 **Switch the input selector on your TV so that the signal from the player appears on your TV screen.**
- 2 **Press \blacktriangle OPEN/CLOSE, and place a disc on the disc tray.**

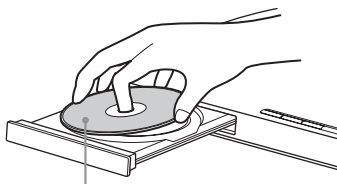

Playing side facing down

- 3 **Press \blacktriangle OPEN/CLOSE to close the disc tray.**
Playback starts.
If playback does not start automatically, select \blacksquare in the [Video] , [Music] , or [Photo] category, and press ENTER.

Enjoying BONUSVIEW/BD-LIVE

Some BD-ROMs with the “BD-LIVE” logo* have bonus content and other data that can be downloaded for your enjoyment.

* BD-LIVE™

- 1 **Connect a USB memory to the USB jack on the player (page 6).**
Use a 1 GB or larger USB memory as your local storage.
- 2 **Prepare for BD-LIVE (BD-LIVE only).**
 - Connect the player to a network (page 11).
 - Set [BD Internet Connection] to [Allow] (page 17).

3 Insert a BD-ROM with BONUSVIEW/BD-LIVE.

The operation method differs depending on the disc. Refer to the instruction manual supplied with the disc.



To delete data in the USB memory, select [Erase BD Data] in the [Video] , and press ENTER. All data stored in the buda folder will be erased.

Displaying the play information

You can view the playback information, etc., by pressing DISPLAY.
The displayed information differs depending on the disc type and player status.

Example: when playing a BD-ROM

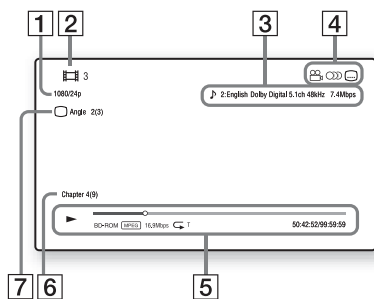

- 1 Output resolution/Video frequency
- 2 Title number or name
- 3 The currently selected audio setting
- 4 Available functions ([Angle] angle, [Audio] audio, [Subtitles] subtitle)
- 5 Playback information
Displays the Play mode, Playing status bar, Disc type, Video codec, Bitrate, Repeat type, Elapsed time, and Total playing time.
- 6 Chapter number
- 7 The currently selected angle

Playing from a USB Device

You can play video/music/photo files from the connected USB device.
For playable USB devices, see page 22.

1 Connect the USB device to the USB jack on the player.

Refer to the instruction manual supplied with the USB device before connecting.

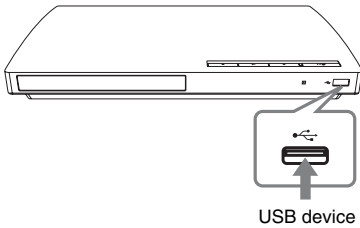

2 Select [Video], [Music], or [Photo] on the home menu using ←/→.

3 Select [USB device] using ↑/↓, and press ENTER.

Playing via a Network

Enjoying Sony Entertainment Network

Sony Entertainment Network serves as a gateway, delivering the selected Internet content and a variety of on-demand entertainment straight to your player.



Some Internet content requires registration via a PC before it can be played.

For further details, visit the following website:
<http://www.sony.com/bluraysupport/>

1 Prepare for Sony Entertainment Network.

Connect the player to a network (page 11).

2 Select [Video], [Music], or [Photo] on the home menu using ←/→.

3 Select an Internet content provider icon using ↑/↓, and press ENTER.

When an Internet content list has not been acquired, an unacquired icon or a new icon is displayed.

To use the control panel

The control panel appears when the video file starts playing. The displayed items may differ depending on Internet content providers. To display again, press DISPLAY.

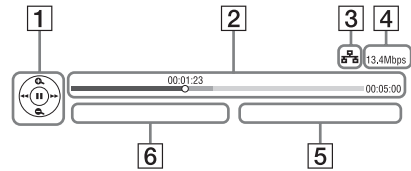

- 1 Control display
Press ←/↑/↓/→ or ENTER for playback operations.
- 2 Playing status bar
Status bar, Cursor indicating the current position, Playing time, Duration of the video file
- 3 Network condition
[Icon] indicates the wired connection.
- 4 Network transmission speed
- 5 The next video file name
- 6 The currently selected video file name

Available Options

Various settings and playback operations are available by pressing **OPTIONS**. The available items differ depending on the situation.

Common options

Item	Details
[Repeat Setting]	Sets the repeat mode.
[Favorites List]	Displays the Favorites List.
[Play]/[Stop]	Starts or stops the playback.
[Play from beginning]	Plays the item from the beginning.
[Add to Favorites]	Adds Internet content to the Favorites List.
[Remove from Favorites]	Removes Internet content from the Favorites List.

[Video] only

Item	Details
[A/V SYNC]	Adjusts the gap between picture and sound, by delaying the sound output in relation to the picture output (0 to 120 milliseconds).
[Video Settings]	<ul style="list-style-type: none"> • [Picture Quality Mode]: Selects the picture settings for different lighting environments. • [BNR]: Reduces the mosaic-like block noise in the picture. • [MNR]: Reduces minor noise around the picture outlines (mosquito noise).
[Pause]	Pauses the playback.
[Top Menu]	Displays the BD's or DVD's Top Menu.
[Menu]/ [Popup Menu]	Displays the BD-ROM's Pop-up Menu or DVD's menu.
[Title Search]	Searches for a title on BD-ROMs/DVD VIDEOS and starts playback from the beginning.
[Chapter Search]	Searches for a chapter and starts playback from the beginning.

Item	Details
[Angle]	Switches to other viewing angles when multi-angles are recorded on BD-ROMs/DVD VIDEOS.
[IP Content Noise Reduction]	Adjusts the picture quality of Internet content.

[Music] only

Item	Details
[Add Slideshow BGM]	Registers music files in the USB memory as slideshow background music (BGM).









[Photo] only

Item	Details
[Slideshow Speed]	Changes the slideshow speed.
[Slideshow Effect]	Sets the effect for slideshows.
[Slideshow BGM]	<ul style="list-style-type: none"> • [Off]: Turns off the function. • [My Music from USB]: Sets the music files registered in [Add Slideshow BGM]. If no music file is registered, [(Not registered)] is displayed. • [Play from Music CD]: Sets the tracks in CD-DAs.
[Slideshow]	Plays a slideshow.
[Rotate Left]	Rotates the photo counterclockwise by 90 degrees.
[Rotate Right]	Rotates the photo clockwise by 90 degrees.

Using the Settings Displays

Select  [Setup] on the home menu when you need to change the settings of the player. The default settings are underlined.

- 1 Select  [Setup] on the home menu using \leftarrow/\rightarrow .
- 2 Select the setup category icon using \uparrow/\downarrow , and press ENTER.

Icon	Explanation
	[Network Update] (page 15) Updates the software of the player.
	[Screen Settings] (page 15) Adjusts the video settings according to the type of connecting jacks.
	[Audio Settings] (page 16) Adjusts the audio settings according to the type of connecting jacks.
	[BD/DVD Viewing Settings] (page 17) Customizes the viewing options.
	[Parental Control Settings] (page 17) Customizes the Parental Control function.
	[System Settings] (page 18) Customizes the player settings.
	[Network Settings] (page 18) Adjusts detailed settings for the Internet and network.
	[Easy Setup] (page 18) 1-2-3 Re-runs the Easy Setup to make the basic settings.
	[Resetting] (page 18) Resets the player to the factory settings.

[Network Update]

Select [OK] to update the player's software via the network.



- We recommend performing the network update every 2 months or so.
- For information about update functions, visit the following website:
<http://www.sony.com/bluraysupport/>

[Screen Settings]

■ [TV Type]

[16:9]: Select this when connecting to a wide-screen TV or a TV with a wide mode function.

[4:3]: Select this when connecting to a 4:3 screen TV without a wide mode function.

■ [Screen Format]

[Original]: Select this when connecting to a TV with a wide mode function. Displays a 4:3 screen picture in 16:9 aspect ratio even on a wide-screen TV.

[Fixed Aspect Ratio]: Changes the picture size to fit the screen size with the original picture aspect ratio.

■ [DVD Aspect Ratio]

[Letter Box]: Displays a wide picture with black bands on the top and bottom.



[Pan & Scan]: Displays a full-height picture on the entire screen, with trimmed sides.

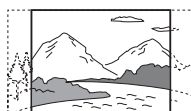

■ [Cinema Conversion Mode]

[Auto]: Normally select this. The player automatically detects whether the material is video-based or film-based, and switches to the appropriate conversion method.

[Video]: The conversion method suited for video-based material will always be selected regardless of the material.

■ [Output Video Format]

[HDMI]: Normally select [Auto]. Select [Original Resolution] to output the resolution recorded on the disc. When the resolution is lower than the SD resolution, it is scaled up to the SD resolution.

[Video]: Automatically sets the lowest resolution.

■ [BD/DVD-ROM 1080/24p Output]

[Auto]: Outputs 1920 × 1080p/24 Hz video signals only when connecting a 1080/24p-compatible TV using the HDMI OUT jack.

[Off]: Select this when your TV is not compatible with 1080/24p video signals.

■ [YCbCr/RGB (HDMI)]

[Auto]: Automatically detects the connected TV type, and switches to the matching color setting.

[YCbCr (4:2:2)]: Outputs YCbCr 4:2:2 video signals.

[YCbCr (4:4:4)]: Outputs YCbCr 4:4:4 video signals.

[RGB]: Outputs RGB video signals.

■ [HDMI Deep Color Output]

[Auto]: Normally select this.

[16bit]/[12bit]/[10bit]: Outputs 16bit/12bit/10bit video signals when the connected TV is compatible with Deep Color.

[Off]: Select this when the picture is unstable or colors appear unnatural.

■ [Pause Mode]

[Auto]: Normally select this. Dynamic moving pictures appear without blurring.

[Frame]: Displays static pictures at high resolution.

[Audio Settings]

■ [Audio (HDMI)]

[Auto]: Normally select this. Outputs audio signals according to the status of the connected HDMI device.

[PCM]: Outputs PCM signals from the HDMI OUT jack.

■ [BD Audio MIX Setting]

[On]: Outputs the audio obtained by mixing the interactive and secondary audio to the primary audio.

[Off]: Outputs the primary audio only. Select this to output HD audio signals to an AV amplifier (receiver).

■ [Dolby Digital]

[Downmix PCM]: Converts to output Linear PCM signals. Select this when connecting an audio device without a built-in Dolby Digital decoder.

[Dolby Digital]: Select this when connecting an audio device with a built-in Dolby Digital decoder.

■ [DTS]

[Downmix PCM]: Converts to output Linear PCM signals. Select this when connecting to an audio device without a built-in DTS decoder.

[DTS]: Select this when connecting to an audio device with a built-in DTS decoder.

■ [DTS Neo:6]

[Cinema]: Outputs the simulated multi-channel sound from 2 channel sources via the HDMI OUT jack according to the capability of the connected device using DTS Neo:6 Cinema mode.

[Music]: Outputs the simulated multi-channel sound from 2 channel sources via the HDMI OUT jack according to the capability of the connected device using DTS Neo:6 Music mode.

[Off]: Outputs the sound with its original number of channels via the HDMI OUT jack.

■ [Audio DRC]

[Auto]: Performs playback at the dynamic range specified by the disc (BD-ROM only). Other discs are played back at the [On] level.
 [On]: Performs playback at a standard compression level.
 [Off]: No compression works. A more dynamic sound is produced.

■ [Downmix]

[Surround]: Outputs audio signals with surround effects. Select this when connecting an audio device that supports Dolby Surround (Pro Logic) or DTS Neo:6.
 [Stereo]: Outputs audio signals without surround effects. Select this when connecting an audio device that does not support Dolby Surround (Pro Logic) or DTS Neo:6.



[BD/DVD Viewing Settings]

■ [BD/DVD Menu]

Selects the default menu language for BD-ROMs or DVD VIDEOS.
 When you select [Select Language Code], the display for entering the language code appears. Enter the code for your language by referring to “Language code list” (page 23).

■ [Audio]

Selects the default track language for BD-ROMs or DVD VIDEOS.
 When you select [Original], the language given priority in the disc is selected.
 When you select [Select Language Code], the display for entering the language code appears. Enter the code for your language by referring to “Language code list” (page 23).

■ [Subtitle]

Selects the default subtitle language for BD-ROMs or DVD VIDEOS.
 When you select [Select Language Code], the display for entering the language code appears. Enter the code for your language by referring to “Language code list” (page 23).

■ [BD Hybrid Disc Playback Layer]

[BD]: Plays BD layer.
 [DVD/CD]: Plays DVD or CD layer.

■ [BD Internet Connection]

[Allow]: Normally select this.
 [Do not allow]: Prohibits Internet connection.



[Parental Control Settings]

■ [Password]

Sets or changes the password for the Parental Control function. A password allows you to set a restriction on BD-ROM or DVD VIDEO, and Internet video playback. If necessary, you can differentiate the restriction levels for BD-ROMs, DVD VIDEOS, and Internet videos.

■ [Parental Control Area Code]

Playback of some BD-ROMs, DVD VIDEOS, or Internet videos can be limited according to the geographic area. Scenes may be blocked or replaced with different scenes. Follow the on-screen instructions and enter your four-digit password.

■ [BD Parental Control]

Playback of some BD-ROMs can be limited according to the age of the users. Scenes may be blocked or replaced with different scenes. Follow the on-screen instructions and enter your four-digit password.

■ [DVD Parental Control]

Playback of some DVD VIDEOS can be limited according to the age of the users. Scenes may be blocked or replaced with different scenes. Follow the on-screen instructions and enter your four-digit password.

■ [Internet Video Parental Control]

Playback of some Internet videos can be limited according to the age of the users. Scenes may be blocked or replaced with different scenes. Follow the on-screen instructions and enter your four-digit password.

■ [Internet Video Unrated]

[Allow]: Allows the playback of unrated Internet videos.

[Block]: Blocks the playback of unrated Internet videos.

[System Settings]

■ [OSD]

Selects on-screen display language for your player.

■ [Control for HDMI]

[On]: The following BRAVIA Sync features are available:

- One-Touch Play
- System Power-Off
- Language Follow

[Off]: Turns off the function.



For details, refer to the instruction manual supplied with the TV or components.

■ [HDMI: Linked to TV-off]

[On]: Automatically turns off the player and HDMI-compatible components when the connected TV enters standby mode (BRAVIA Sync).

[Off]: Turns off the function.

■ [Auto Display]

[On]: Automatically displays information on the screen when changing the viewing titles, picture modes, audio signals, etc.

[Off]: Displays information only when you press DISPLAY.

■ [Screen Saver]

[On]: Turns on the screen saver function. The screen saver image appears when you do not use the player for more than 10 minutes while an on-screen display is displayed.

[Off]: Turns off the function.

■ [Software Update Notification]

[On]: Sets the player to inform you of newer software version information (page 15).

[Off]: Turns off the function.

■ [System Information]

Displays the player's software version information and the MAC address.



[Network Settings]

■ [Internet Settings]

Connect the player to the network beforehand. For details, see "Connecting to the Network" (page 11).

[View Network Status]: Displays the current network status.

[Wired Setup]: Select this when you connect to a broadband router using a LAN cable.



For further details, visit the following website and check the FAQ contents:

<http://www.sony.com/bluraysupport/>

■ [Network Connection Diagnostics]

Checks for the proper network connection by running the network diagnostics.



1-2-3 [Easy Setup]

Re-runs the [Easy Setup] to make the basic settings. Follow the on-screen instructions.



[Resetting]

■ [Reset to Factory Default Settings]

You can reset the player settings to the factory default by selecting the group of settings. All the settings within the group will be reset.

■ [Initialize Personal Information]

You can erase your personal information stored in the player.

Troubleshooting

If you experience any of the following difficulties while using the player, use this troubleshooting guide to help remedy the problem before requesting repairs. Should any problem persist, consult your nearest Sony dealer.

Picture

There is no picture or the picture is not output correctly.

- ➔ Check that all the connecting cables are securely connected (page 9).
- ➔ Switch the input selector on your TV to display the signal from the player.
- ➔ Reset the video output resolution to the lowest resolution by pressing **■** on the player for more than 10 seconds.
- ➔ For HDMI connections, try the following:
 - ① Turn the player off and on again.
 - ② Turn the connected equipment off and on again.
 - ③ Disconnect and then reconnect the HDMI cable.
- ➔ The HDMI OUT jack is connected to a DVI device that does not support copyright protection technology.
- ➔ For HDMI connections, check the [Output Video Format] settings in the [Screen Settings] setup (page 16).
- ➔ When the analog signals are output, set [BD/DVD-ROM 1080/24p Output] to [Off] in the [Screen Settings] setup (page 16).
- ➔ For BD-ROMs, check the [BD/DVD-ROM 1080/24p Output] setting in the [Screen Settings] setup (page 16).

The display language on the screen switches automatically when connected to the HDMI OUT jack.

- ➔ When [Control for HDMI] is set to [On] (page 18), the display language on the screen automatically switches according to the language setting of the connected TV (if you change the setting on your TV, etc.).

Sound

There is no sound or the sound is not output correctly.

- ➔ Check that all the connecting cables are securely connected (page 9).
- ➔ Switch the input selector on your AV amplifier (receiver) so that the audio signals of the player are output from your AV amplifier (receiver).
- ➔ If the audio signal does not come through the DIGITAL OUT (COAXIAL)/HDMI OUT jack, check the audio settings (page 16).
- ➔ For HDMI connections, try the following:
 - ① Turn the player off and on again.
 - ② Turn the connected equipment off and on again.
 - ③ Disconnect and then reconnect the HDMI cable.
- ➔ For HDMI connections, if the player is connected to a TV through an AV amplifier (receiver), try connecting the HDMI cable directly to the TV. Refer also to the instruction manual supplied with the AV amplifier (receiver).
- ➔ The HDMI OUT jack is connected to a DVI device (DVI jacks do not accept audio signals).
- ➔ The device connected to the HDMI OUT jack does not support the audio format of the player. Check the audio settings (page 16).

The HD Audio (Dolby Digital Plus, Dolby TrueHD, DTS-HD High Resolution Audio, and DTS-HD Master Audio) is not output by bitstream.

- ➔ Set [BD Audio MIX Setting] to [Off] in the [Audio Settings] setup (page 16).
- ➔ Check that the connected AV amplifier (receiver) is compatible with each HD Audio format.

The interactive audio is not output.

- ➔ Set [BD Audio MIX Setting] to [On] in the [Audio Settings] setup (page 16).

Disc

The disc does not play.

- ➔ The disc is dirty or skewed.
- ➔ The disc is upside down. Insert the disc with the playback side facing down.
- ➔ The disc has a format that cannot be played back by this player (page 22).
- ➔ The player cannot play a recorded disc that is not correctly finalized.
- ➔ The region code on the BD or DVD does not match the player.

USB device

The player does not detect a USB device connected to the player.

- ➔ Make sure that the USB device is securely connected to the USB jack.
- ➔ Check if the USB device or a cable is damaged.
- ➔ Check if the USB device is on.
- ➔ If the USB device is connected via a USB hub, connect the USB device directly to the player.

Sony Entertainment Network

The picture/sound is poor/certain programs display a loss of detail, especially during fast-motion or dark scenes.

- ➔ Picture/sound quality may be poor depending on Internet content providers.
- ➔ Picture/sound quality may be improved by changing the connection speed. Recommended connection speed is of at least 2.5 Mbps for standard definition video (10 Mbps for high definition video).
- ➔ Not all videos will contain sound.

The picture is small.

- ➔ Press **↑** to zoom in.

Network connection

The player cannot connect to the network.

- ➔ Check the network connection (page 11) and the network settings (page 18).

The message [A new software version is available. Please go to the "Setup" section of the menu and select "Network update" to perform the update.] appears on the screen when turning the player on.

- ➔ See [Network Update] (page 15) to update the player to a newer software version.

Control for HDMI (BRAVIA Sync)

The [Control for HDMI] function does not work (BRAVIA Sync).

- ➔ Check that [Control for HDMI] is set to [On] (page 18).
- ➔ If you change the HDMI connection, turn the player off and on again.
- ➔ If power failure occurs, set [Control for HDMI] to [Off], then set [Control for HDMI] to [On] (page 18).
- ➔ Check the following and refer to the instruction manual supplied with the component.
 - the connected component is compatible with the [Control for HDMI] function.
 - the connected component's setting for the [Control for HDMI] function is correct.
- ➔ When you connect the player to a TV through an AV amplifier (receiver),
 - if the AV amplifier (receiver) is not compatible with the [Control for HDMI] function, you may be unable to control the TV from the player.
 - if you change the HDMI connection, disconnect and reconnect the AC power cord, or a power failure occurs, try the following: ①Switch the input selector of the AV amplifier (receiver) so that the picture from the player appears on the TV screen. ②Set [Control for HDMI] to [Off], then set [Control for HDMI] to [On] (page 18). Refer to the instruction manual supplied with the AV amplifier (receiver).

The System Power-Off function does not work (BRAVIA Sync).

- ➔ Check that [Control for HDMI] and [HDMI: Linked to TV-off] are set to [On] (page 18).

Others



Playback does not start from the beginning of content.

- ➔ Press **OPTIONS**, and select [Play from beginning].

Playback does not start from the resume point where you last stopped playing.

- ➔ The resume point may be cleared from memory depending on the disc when
- you open the disc tray.
 - you disconnect the USB device.
 - you play other content.
 - you turn off the player.

The disc tray does not open and you cannot remove the disc even after you press .

- ➔ Try the following: ①Turn the player off, and disconnect the AC power cord. ②Reconnect the AC power cord while pressing down  on the player. ③Keep pressing down  on the player until the tray opens. ④Remove the disc. ⑤Hold down  on the player for more than 10 seconds until the player turns off.

The player does not respond to any button.

- ➔ Moisture has condensed inside the player (page 3).
- ➔ Hold down  on the player for more than 10 seconds until the player turns off.
- If the player still does not respond to any button, disconnect then reconnect the AC power cord.

Specifications

System

Laser: Semiconductor laser

Inputs and outputs

(Jack name:

Jack type/Output level/Load impedance)

LINE OUT R-AUDIO-L:

Phono jack/2 Vrms/10 kilohms

DIGITAL OUT (COAXIAL):

Phono jack/0.5 Vp-p/75 ohms

HDMI OUT:

HDMI 19-pin standard connector

LINE OUT VIDEO:

Phono jack/1.0 Vp-p/75 ohms

LAN (100):

100BASE-TX Terminal

USB:

USB jack Type A, maximum current 500 mA (For connecting USB device)

General

Power requirements:

120V AC, 60Hz

Power consumption:

10 W

Dimensions (approx.):

290 mm × 196 mm × 43 mm
(11 1/2 in. × 7 3/4 in. × 1 3/4 in.)
(width/depth/height) incl. projecting parts

Mass (approx.):

1.1 kg (2 lb 6 3/4 oz)

Operating temperature:

5 °C to 35 °C (41 °F to 95 °F)

Operating humidity:

25 % to 80 %

Supplied accessories

- Audio/video cable (phono plug ×3) (1)
- HDMI cable (1) (BDP-BX18 only)
- Remote commander (remote) (1)
- Size AA (R6) batteries (2)

Specifications and design are subject to change without notice.

Playable discs

Blu-ray Disc *1	BD-ROM BD-R*2/BD-RE*2
DVD *3	DVD-ROM DVD-R/DVD-RW DVD+R/DVD+RW
CD *3	CD-DA (Music CD) CD-ROM CD-R/CD-RW

*1 Since the Blu-ray Disc specifications are new and evolving, some discs may not be playable depending on the disc type and the version. The audio output differs depending on the source, connected output jack, and selected audio settings.

*2 BD-RE: Ver.2.1
BD-R: Ver.1.1, 1.2, 1.3 including organic pigment type BD-R (LTH type)
The BD-Rs recorded on a PC cannot be played if postscripts are recordable.

*3 A CD or DVD disc will not play if it has not been correctly finalized. For more information, refer to the instruction manual supplied with the recording device.

Discs that cannot be played

- BDs with cartridge
- BDXLs
- DVD-RAMs
- HD DVDs
- DVD Audio discs
- PHOTO CDs
- Data part of CD-Extras
- Super VCDs
- Audio material side on DualDiscs
- A disc recorded in a color system other than NTSC, such as PAL (this player conforms to the NTSC color system).

Note on Discs

This product is designed to playback discs that conform to the Compact Disc (CD) standard. DualDiscs and some of the music discs encoded with copyright protection technologies do not conform to the Compact Disc (CD) standard, therefore, these discs may not be playable by this product.

Note on playback operations of BDs/DVDs

Some playback operations of BDs/DVDs may be intentionally set by software producers. Since this player plays BDs/

DVDs according to the disc contents the software producers designed, some playback features may not be available.

Note about double-layer BDs/DVDs

The playback pictures and sound may be momentarily interrupted when the layers switch.

Region code (BD-ROM/DVD VIDEO only)

Your player has a region code printed on the rear of the unit and will only play BD-ROMs/ DVD VIDEOS labeled with identical region codes or .



Playable types of files

Video

File format	Extensions
MPEG-1 Video/PS*1 MPEG-2 Video/PS, TS*1	“.mpg,” “.mpeg,” “.m2ts,” “.mts”
MPEG-4 AVC*1	“.mkv,” “.mp4,” “.m4v,” “.m2ts,” “.mts”
WMV9*1	“.wmv,” “.asf”
AVCHD	*2
Xvid	“.avi”

Music

File format	Extensions
MP3 (MPEG-1 Audio Layer III)	“.mp3”
AAC*1*3	“.m4a”
WMA9 Standard*1*3	“.wma”
LPCM	“.wav”

Photo

File format	Extensions
JPEG	“.jpg,” “.jpeg”

*1 The player does not play coded files such as DRM.

*2 The player plays AVCHD format files that are recorded on a digital video camera, etc. The

AVCHD format disc will not play if it has not been correctly finalized.

*3 The player does not play coded files such as Lossless.



- Some files may not play depending on the format, the encoding, or recording condition.
- Some files edited on a PC may not play.
- The player can recognize the following files or folders in BDs, DVDs, CDs and USB devices:
 - up to folders in the 3rd tree
 - up to 500 files in a single tree
- Some USB devices may not work with this player.
- The player can recognize Mass Storage Class (MSC) devices, Still Image Capture Device (SICD) class devices and 101 keyboard.
- To avoid data corruption or damage to the USB memory or devices, turn off the player when connecting or removing the USB memory or devices.
- The player may not play high bit rate video files on DATA CDs smoothly. You are recommended to play such files using DATA DVDs.

Notes About the Discs

- To keep the disc clean, handle the disc by its edge. Do not touch the surface. Dust, fingerprints, or scratches on the disc may cause it to malfunction.



- Do not expose the disc to direct sunlight or heat sources such as hot air ducts, or leave it in a car parked in direct sunlight as the temperature may rise considerably inside the car.
- After playing, store the disc in its case.
- Clean the disc with a cleaning cloth. Wipe the disc from the center out.



- Do not use solvents such as benzine, thinner, commercially available disc/lens cleaners, or anti-static spray intended for vinyl LPs.
- If you have printed the disc's label, dry the label before playing.
- Do not use the following discs.

- A lens cleaning disc.
- A disc that has a non-standard shape (e.g., card, heart).
- A disc with a label or sticker on it.
- A disc that has cellophane tape or sticker adhesive on it.
- Do not resurface the playing side of a disc to remove surface scratches.

Code numbers of controllable TVs

While holding down -TV- , enter the TV manufacturer's code using the number buttons.

If more than one code number is listed, try entering them one at a time until you find the one that works with your TV.

Manufacturer	Code number
Sony	01 (default)
Hitachi	02
LG/Goldstar	04
Mitsubishi/MGA	13
NEC	04
Panasonic	19
Philips	21
Pioneer	16
RCA	10
Samsung	20
Sharp	18
Toshiba	07

Language code list

For details, see [BD/DVD Viewing Settings] (page 17).

The language spellings conform to the ISO 639: 1988 (E/F) standard.

Code	Language
1027	Afar
1032	Afrikaans
1044	Arabic
1051	Aymara
1053	Bashkir
1059	Bulgarian
1061	Bislama
1067	Tibetan
1028	Abkhazian
1039	Amharic
1045	Assamese
1052	Azerbaijani
1057	Byelorussian
1060	Bihari
1066	Bengali
1070	Breton

Code	Language	Code	Language
1079	Catalan	1093	Corsican
1097	Czech	1103	Welsh
1105	Danish	1109	German
1130	Bhutani; Dzongkha	1142	Greek
1144	English	1145	Esperanto
1149	Spanish	1150	Estonian
1151	Basque	1157	Persian
1165	Finnish	1166	Fiji
1171	Faroese	1174	French
1181	Frisian	1183	Irish
1186	Scots Gaelic	1194	Galician
1196	Guarani	1203	Gujarati
1209	Hausa	1217	Hindi
1226	Croatian	1229	Hungarian
1233	Armenian	1235	Interlingua
1239	Interlingue	1245	Inupiak
1248	Indonesian	1253	Icelandic
1254	Italian	1257	Hebrew
1261	Japanese	1269	Yiddish
1283	Javanese	1287	Georgian
1297	Kazakh	1298	Greenlandic; Kalaallisut
1299	Cambodian; Khmer	1300	Kannada
1301	Korean	1305	Kashmiri
1307	Kurdish	1311	Kirghiz
1313	Latin	1326	Lingala
1327	Laothian; Lao	1332	Lithuanian
1334	Latvian	1345	Malagasy
1347	Maori	1349	Macedonian
1350	Malayalam	1352	Mongolian
1353	Moldavian	1356	Marathi
1357	Malay	1358	Maltese; Maltese
1363	Burmese	1365	Nauru
1369	Nepali	1376	Dutch
1379	Norwegian	1393	Occitan
1403	Oromo	1408	Oriya
1417	Punjabi; Panjabi	1428	Polish
1435	Pashto; Pushto	1436	Portuguese
1463	Quechua	1481	Rhaeto- Romance
1482	Kirundi; Rundi	1483	Romanian
1489	Russian	1491	Kinyarwanda
1495	Sanskrit	1498	Sindhi
1501	Sangho; Sango	1502	Serbo-Croatian
1503	Singhalese; Sinhalese	1505	Slovak
1506	Slovenian	1507	Samoan
1508	Shona	1509	Somali
1511	Albanian	1512	Serbian
1513	Siswati; Swati	1514	Sesotho; Sotho southern
1515	Sundanese	1516	Swedish
1517	Swahili	1521	Tamil
1525	Telugu	1527	Tajik
1528	Thai	1529	Tigrinya
1531	Turkmen	1532	Tagalog
1534	Setswana; Tswana	1535	Tonga; Tonga islands

Code	Language	Code	Language
1538	Turkish	1539	Tsonga
1540	Tatar	1543	Twi
1557	Ukrainian	1564	Urdu
1572	Uzbek	1581	Vietnamese
1587	Volapük	1613	Wolof
1632	Xhosa	1665	Yoruba
1684	Chinese	1697	Zulu
1703	Not specified		

Parental control/area code

For details, see [Parental Control Area Code] (page 17).

Code	Area	Code	Area
2044	Argentina	2047	Australia
2046	Austria	2057	Belgium
2070	Brazil	2090	Chile
2092	China	2093	Colombia
2115	Denmark	2165	Finland
2174	France	2109	Germany
2200	Greece	2219	Hong Kong
2248	India	2238	Indonesia
2239	Ireland	2254	Italy
2276	Japan	2304	Korea
2333	Luxembourg	2363	Malaysia
2362	Mexico	2376	Netherlands
2390	New Zealand	2379	Norway
2427	Pakistan	2424	Philippines
2428	Poland	2436	Portugal
2489	Russia	2501	Singapore
2149	Spain	2499	Sweden
2086	Switzerland	2543	Taiwan
2528	Thailand	2184	United Kingdom

Index

A

AUDIO 7
Audio Settings 16

B

BD/DVD Viewing
 Settings 17
BD-LIVE 12
BD-R 22
BD-RE 22
Bitstream 19
Blu-ray Disc 22
BONUSVIEW 12
BRAVIA Sync 20

C

Child Lock 6
Color buttons 7
Connecting
 AV amplifier
 (Receiver) 10
 Network 11
 TV 9
Control for HDMI 18, 20

D

Deep Color 16
DISPLAY 7
Dolby Digital 16
DTS 16

E

Easy Setup 11, 18

H

HDMI 16
HOME 7, 15
Home menu 15

I

Internet content 13
IP Content Noise
 Reduction 14

M

MAC address 18

N

NETFLIX 8
Network Settings 18
Network Update 15

O

OPTIONS 7
OSD 18

P

Parental Control 17
Parental Control Settings
 17
Play information 12
Playable discs 22
POP UP/MENU 7

R

Region code 22
Remote 7
Resetting 18
Resetting the player 18
Resume 8, 21

S

Screen Settings 15
SEN 8
Setup 15
Software update 15, 18
Sony Entertainment
 Network 13
SUBTITLE 7
System Settings 18

T

TOP MENU 7
Troubleshooting 19
TV Type 15

U

Update 15
USB 13

The software of this player may be updated in the future. For information about any available updates and the latest Operating Instructions, please visit the following website:
<http://www.sony.com/bluraysupport/>

AVCHD™

HDMI



BD-LIVE™



DVD
VIDEO

COMPACT
disc
DIGITAL AUDIO



BRAVIA
Sync

PhotoTV
HD

Java
POWERED

<http://www.sony.net/>

Printed on 70% or more recycled paper using VOC (Volatile Organic Compound)-free vegetable oil based ink.

4-290-281-12(1)

Printed in Malaysia

